

2x30W Commercial Downlight

- All directional Gyro Tiltable;
- Low glare interchangeable lens;
- Interchangeable snoot & honeycomb;
- Air Dynamic heatsink;
- Screw installation;

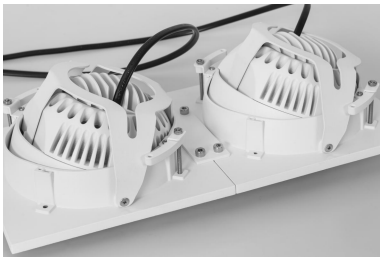

All directional tilt &
air Dynamic heatsink;



Magnet bezel+
Screw installation;

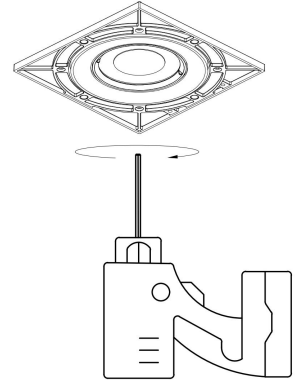
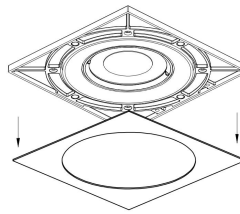

Interchangeable snoot &
add on honeycomb louvre;

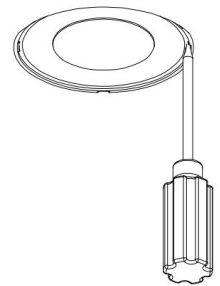
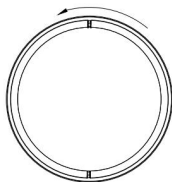

Low glare interchangeable lens;

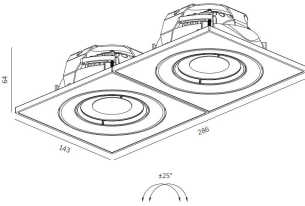

265*130mm
5-25mm

DL3686

2x30W Round Atom Downlight

Description

Gyro Tiltable;
Low glare interchangeable lens;
Air Dynamic heatsink;
Screw installation;

Finish

Black/White

Material

Aluminium

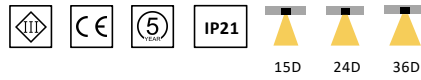

TECHNICAL CHARACTERISTICS

Light source

Light source: Luminus CXM-14-30-90-36-AC32-F4-3
Output (W): 2x25.2W (2x700mA 36V)
Total power consumption (W): 2x30W
Color temperature: 2700K/3000K/4000K
CRI: 90
Photobiological risk: RG1
Real Lumen: 4962lm
Qty Leds: 2pcs
Lm/Real W: 94.35lm
Life Time: 50.000h L80B20
MacAdam steps: 3
UGR: 19

Gear

This product is supplied without gear;
Recommended 2PCS Osram non dimmable
OT FIT 30/220-240/700 CS

Luminaire

Downlight suitable for indoor area
crossing: No
Warranty: 5 Years

LIGHT DISTRIBUTION for 3000K Medium 36°

h(m)	E(lx)	Ø(m)
1	10209	Ø0.71
2	2552	Ø1.41
3	1134	Ø2.12
4	638	Ø2.83
5	408.3	Ø3.53

The photograph may not match the reference exactly. Please read the product description to identify the finish.